

HD3CHS

SUPER HIGH RESOLUTION DAY/NIGHT COLOR INDOOR MINI-DOME CAMERAS

Honeywell's HD3CHS indoor fixed mini-dome camera is the latest addition to the HD3 Series. This compact, integrated solution takes dome cameras to places never before thought possible. No matter how demanding the environment, HD3CHS delivers outstanding image quality under almost any light conditions. The 1/3" CCD sensor offers the latest in digital video surveillance technology with accurate color rendition through a wide variety of lighting conditions.

The HD3CHS incorporates the latest Digital Signal Processing (DSP) and Digital Noise Reduction (DNR) technology to produce extremely sharp and clear images regardless of lighting levels. DNR removes noise artifacts, increasing the performance of motion detection and typically providing longer recording durations on digital and network video recorders. Producing 540 TV lines of crisp, clear horizontal resolution with a minimum illumination of 0.2 lux, the HD3CHS reproduces sharper images down to the smallest detail with outstanding accuracy. A 2.8-10 mm Vari-focal Auto Iris lens covers a wide range of viewing angles. Picture adjustment after installation is easy with the 3-D axis gimbal that is capable of 360° of pan, 160° of tilt and 360° of horizontal rotation.

The HD3CHS integrates a camera and lens into a compact, one-piece design for fast and easy installation. The surface mount offers easy installation directly to a ceiling, wall, or 2S single gang box. A wall/pendant mount kit is available in off white for inconspicuous installation in virtually any application. A service/monitor cable is included for easy on-site adjustments.

The HD3CHS accepts either 12 VDC or 24 VAC (auto sensing) for proper operation and flexible installation. The Automatic Backlight Compensation (BLC) and Auto Tracking White Balance (ATW) ensure crisp color images in dark or backlit environments such as windows and doorways. The Automatic Gain Control (AGC) feature increases the signal strength from the camera when scene lighting is low, keeping the picture sharp and viewable.

Market Opportunities

The compact, one-piece design installs quickly and easily in commercial or government facilities, schools, casinos, retail stores or hospitals. Enhanced picture quality, true color reproduction, and excellent low light performance makes the HD3CHS ideal for a wide range of indoor surveillance applications.

Features

- 1/3" SuperHAD2 Sony CCD
- Super high resolution color: 540 TV lines
- Polycarbonate housing and dome
- Digital Noise Reduction technology for noise free images
- On Screen Display menu for easy setup
- Clear dome with liner for discreet surveillance with no light loss
- 2.8-10 mm (F1.2) Vari-focal Auto Iris lens
- Local video output for setup
- 3-D axis gimbal
- Line Lock with OSD phase adjustment (24 VAC)
- Dual 12 VDC/24 VAC voltage



SPECIFICATIONS

Operational	HD3CHS	HD3CHSX
Video Standard	NTSC	PAL
Scanning System	525 lines 2:1 interlace	625 lines 2:1 interlace
Image Sensor	1/3" SuperHAD2 (Sony) CCD	
Number of Pixels (H x V)	768 x 494	811 x 508
Minimum Illumination	0.2 lux @ F1.2 (AGC on, 50 IRE)	
Horizontal Resolution	540 TVL	
Video Output	1.0 Vp-p, composite @ 75 Ohms	
Sync System	12 VDC: Internal, 24 VAC: Line Lock	
S/N Ratio	>50 dB (AGC Off)	
Auto Gain Control	Low/Mid/High/Off, selectable	
Lens Iris Control	Direct Drive (DC) Auto Iris	
Automatic Electronic Shutter	1/60-1/100,000 second (NTSC) 1/50-1/100,000 second (PAL)	
White Balance	ATW/AWB/AWC > Set Manual/Indoor/Outdoor	
BLC	Low/Mid/High/Off, switchable	
Gamma	0.45, adjustable	
Sense-Up	Off/Auto	
D-WDR	Off/On	
Privacy Mask	8 mask areas, configurable	
Motion Detection	4 motion detection areas, configurable	
Mirror	Off/Mirror/V-Flip/Rotate, selectable	
3DNR	Off/On, adjustable	
Lens Type	2.8-10 mm, Vari-focal Auto Iris, F1.2	
Electrical		
Input Voltage	12 VDC/24 VAC	
Input Range	11-16 VDC, 17-28 VAC	
Surge Suppression	1.5 kW transient	
Power Consumption	3.0 W (max)	
Mechanical		
Dimensions (W x H x D)	See Diagram	
Weight	0.66 lb (.3 kg) max	
Construction	Housing: Polycarbonate Dome: Polycarbonate Finish: Matte texture, off white	
Connectors	Video Output: BNC connector Power Input: (Screw terminal block)	

Environmental	
Temperature	Operating: -14°F to 122°F (-10°C to 50°C) Storage: -4°F to 140°F (-20°C to 60°C)
Relative Humidity	0% to 90% non-condensing
Accessories	
Mounts	
HD3-MK1	Wall/Pendant Mount Kit, Off White
Regulatory	
Emissions	FCC, CE (EN55022)
Immunity	CE (EN50130-4)
Safety	EU: LVD 2006/95/EC

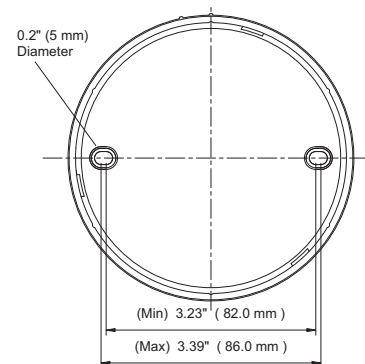
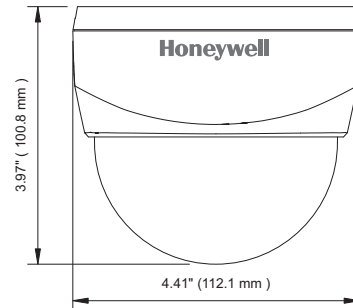

Ordering	
HD3CHS	1/3" CCD High Resolution, Day/Night Indoor Dome Camera, Off White Housing, 540 TVL, 2.8-10 mm VFAI, NTSC
HD3CHSX	1/3" CCD High Resolution, Day/Night Indoor Dome Camera, Off White Housing, 540 TVL, 2.8-10 mm VFAI, PAL

Automation and Control Solutions

Honeywell Systems
2700 Blankenbaker Pkwy, Suite 150
Louisville, KY 40299
1.800.796.2288
www.honeywell.com

L/HD3CHSD/D
May 2011
© 2010 Honeywell International Inc.

Honeywell